

Mopho

Operation Manual



Dave Smith
INSTRUMENTS

Mopho

Operation Manual

Version 1.1
August 2010

Dave Smith Instruments
1210 Cabrillo Hwy N
Half Moon Bay, CA 94019-1449
USA

©2010 Dave Smith Instruments

www.DaveSmithInstruments.com



Tested To Comply
With FCC Standards
FOR OFFICE USE



This device complies with Part 15 of the FCC Rules. Operation is subject to the following two conditions:
(1) This device may not cause harmful interference and
(2) this device must accept any interference received, including interference that may cause undesired operation.

This Class B digital apparatus meets all requirements of the Canadian Interference-Causing Equipment Regulations.

Cet appareil numérique de la classe B respecte toutes les exigences du Règlement sur le matériel brouilleur du Canada.

For Technical Support, email: support@davesmithinstruments.com

Contents

Quick Start.....	1
Getting Connected	3
Basic Operation.....	5
Global Parameters	9
Oscillators.....	13
Mixer.....	16
Filter	17
Envelopes.....	18
LFO	19
Sequencer	21
Modulators.....	26
Miscellaneous Modulators.....	27
Clock	28
Miscellaneous Parameters.....	30
Modulation Sources	32
Modulation Destinations.....	33
Using USB.....	35
Using Audio In.....	37
Using Poly Chain.....	38
Support.....	41
MIDI Implementation	43
MIDI Messages.....	44
NRPN Messages	47
Global Parameter Data.....	48
Program Parameter Data	50
Sysex Messages	57
Packed Data Format.....	59

Quick Start

Thanks for purchasing your Mopho synthesizer! Listen to the sounds, twiddle some knobs, have some fun!

Please Register!

Please go to www.davesmithinstruments.com and register your synth. If you purchased directly from us, there is no need to register—we already have your contact information.

Powering Up

Plug in the power supply, connect (in stereo!) to your mixer/sound system, and start playing!

Try applying keyboard pressure (aftertouch) and the mod wheel. Many sounds are fairly simple at first, then come alive when you use the controllers. With other sounds, you may need to hold the notes a while to let the sound unfold. Playing in different ways has a big effect on the programs.

Selecting and Editing Programs and Global Settings

You can use the increment and decrement (Inc/Yes and Dec/No) switches to step through the programs. Use Param 1 to scroll quickly through the programs. Param 2 changes banks. There are 3 banks of 128 programs.

If you want to edit a program, just turn any knob. The new value will be displayed in the bottom line of the LCD (the top line displays the programmed value for handy reference).

After turning knobs, just hit Program so the LCD goes back to the program/bank screen, allowing you to change programs again.

Press and hold Program briefly to display the Global menu and change higher level parameters such as MIDI channel number, Transpose/Detune, and so on. The Param 1 knob changes the displayed page and Param 2 or increment and decrement change the values. These settings are remembered when the synth is turned off.

Summary

You should be up and running now; for more operation information, read on. Or, just look up specific parameters for detailed notes. Pages 32 and 33 contain a handy reference for mod sources and destinations. At some point you should read through the manual to discover all the little features that you might not notice at first.

Don't forget you get a free editor for Mac OS or Windows with your purchase. Download it from www.soundtower.com/mopho.

I should mention that this manual does not include explanations of basic analog synthesizer functions. It assumes you already know what an oscillator is, how a low-pass filter affects the sound, what an ADSR envelope looks like, and so on.

Fortunately, these days it is quite easy to find such resources on the Internet. If you want to learn the lingo and the basics, just try a search in Google (or the search engine of your choice), something like “analog synthesizer tutorial.” You'll find plenty of good reading material.

Have fun!

Dave Smith

Special thanks to:

The DSI Team: Chris Hector, Andrew McGowan, Joanne McGowan, and Tracy Wadley. Thanks also to Alan Crarer and Jeff Tilley.

Getting Connected

Mopho has several inputs and outputs on its back panel.

Power Input — Connect the power supply included with your Mopho. The power supply comes with different AC adaptor prongs that enable it to work almost anywhere in the world. If for whatever reason you need to use a different supply, it must match the specifications printed on the front panel.

Note: The power supply label says “Evolver” on it; we use the same supply for the Mophos, mono Evolvers, Prophets, and Tetra.

USB—Mopho transmits and receives MIDI data via this standard, Type B, USB receptacle. See *Using USB* on page 35 for more information.

MIDI In—To receive MIDI data from another device, connect this to the other device's MIDI Out.

MIDI Out/Thru—To send MIDI data to another device, connect this to the other device's MIDI In. This output can also be configured as a MIDI Thru using the MIDI Out Select parameter in the Global menu.

Poly Chain—Multiple synths can be poly chained for increased polyphony. For details, see *Using Poly Chain* on page 38.

Note: When Poly Chain is turned off in the Global menu, the Poly Chain output simply mirrors the MIDI Out and transmits the same data.

Sustain—Accepts a momentary, normally open or normally closed footswitch to control sustain or to latch the arpeggiator. See “Sustain” under *Global Parameters* on page 9 for more information.

Pedal/CV—This input can be connected to two types of controllers: a standard expression pedal that has a variable resistor on a TRS (tip-ring-sleeve) ¼ inch phone plug, or a synthesizer or other device capable of producing a control voltage. The control voltage range is 0 to 3.3 volts DC, and the input is protected against higher and negative voltages. For more information, see “Pedal” in *Global Parameters* on page 9 and *Miscellaneous Parameters* on page 30.

Note: This input is heavily filtered for smooth, clean operation, so there is a limit to the speed at which it will respond.

Audio In—Mopho can be used as a signal processor. Audio is routed through the filter, envelopes, and VCA and—when the signal level is high enough—a gate is generated. See *Using Audio In* on page 37.

Audio can also be used to advance the sequencer when Seq Trigger is set to Audio In. See *Sequencer* on page 21 for more information.

Left Out/Right Out—Mopho's unbalanced left and right outputs.

Phones—A ¼ inch stereo headphone jack.

Basic Operation

If you're familiar with analog, subtractive synthesis there shouldn't be anything that looks terribly foreign or strange about Mopho's front panel. All of the basic building blocks are there. But one of the challenges of making a compact synth is giving the user access to all the parameters within a limited amount of panel area. Mopho has most of the parameters of the Prophet '08, plus a couple more, with a front panel that is more than 55% smaller!

Fortunately, several of the synth components have similar control requirements. For example, Mopho has two oscillators and both oscillators have identical control parameters. With a switch to select oscillator 1 or 2, one set of controls can do double duty. Another set of controls handles most of the parameters for all three envelope generators. And you can select both oscillators or all three envelopes to edit a parameter simultaneously in all of them.

Other, less frequently used parameter names appear in light gray above the corresponding knob or switch. Turn on Shift to access those parameters.

And finally, program-level parameters that are not typically performance oriented are found in the Miscellaneous Parameters section.

The front panel is arranged so that the basic signal path components are in order from left to right in the row closest to the keyboard: oscillators into mixer into filter. (The VCA is the last part of the signal chain, but other than the Amplifier Envelope, the only other control directly associated with the VCA is VCA Level, which is in Miscellaneous Parameters.) The second row consists of various modulators, including envelopes, LFOs, and the sequencer. The remaining programmable parameters are for turning the arpeggiator and sequencer on and off, setting the tempo and note value, and the aforementioned Miscellaneous Parameters.

Non-Programmable Controls

The front panel controls can be divided into two groups, programmable and non-programmable. Everything contained within a gray "module" is programmable. The non-programmable controls are for things like selecting programs and transposing the keyboard. Their state—on, off, transposed, whatever—is not saved along with the program.

Transpose—Allows the keyboard to be transposed in one octave increments two octaves up or down. When transposed one octave, the corresponding LED will be lighted, but dim. If the LED is brightly lit, Mopho is transposed two octaves.

Shift—Used to access the shifted parameters.

Program—Press to return Mopho to program mode. Hold to select global mode.

Compare—When editing a Program, press Compare to hear the saved version. Turn Compare off to return to the edited version. Compare can also be used to audition write destinations when moving a program.

Write—Press Write to save the program and write any edits to memory. You can write the program to the same location or choose a different program number using Param 1; Param 2 chooses the bank. Press Inc/Yes to confirm the write and Dec/No (or Write again) to abort.

While there is a write pending, press Compare to hear the program in the target destination prior to saving. Just be sure to turn Compare off before you actually hit the Inc/Yes switch to save.

Param 1—Used to scroll through programs in program mode. In global mode, used for scrolling through the global menu items.

Param 2—Used to change banks in program mode and edit the displayed parameter in edit and global modes.

Inc/Yes and Dec/No—Increment or decrement programs in program mode or values in edit mode and global mode. Also used to confirm or cancel/abort an operation.

Push It—Push It is a manual trigger. Its behavior depends upon the Push It Mode, Note, and Velocity settings, which are programmable. Why is a manual trigger necessary when there are already 32 other manual triggers (that is, the keys)? It is surprisingly handy, especially in Toggle mode. It can be used to start and stop the sequencer or to just latch a droning note on. And that frees up both hands to twist knobs!

Tap Tempo—With Shift on, Push It becomes Tap Tempo for setting the internal clock's BPM.

If Push It is set to Toggle mode and Sequence and Shift are on, tap five times to set the tempo and toggle the Push It Note on, starting the sequencer. That is, a 4-count to set the tempo and then a tap on beat 1 to start. To stop, turn Shift off and press Push It again.

Tap Tempo can also be used to change the tempo while a sequence is playing. If Shift is on while a sequence is playing, tap the button 5 times and the sequence speed will change to the tapped tempo on the fifth hit. You can continue to tap the button, slowing down or speeding up, and the sequence tempo will adjust accordingly. The sequence will average and smooth out any small timing differences.

Modes of Operation

Mopho has three operating modes: program, edit, and global. In program mode, Param 1, Param 2, and Inc/Dec are used to change from one saved program to another. As soon as any of the programmable parameters are edited, that parameter is displayed on the LCD, with the programmed value on the top line, and the new, edited value on the bottom line. That is edit mode. To exit edit mode and return to program mode, just press Program.

To enter global mode, briefly press and hold Program until the light goes off and a global parameter is displayed on the LCD. Param 1 scrolls through the items in the global menu and Param 2 and Inc/Dec change the values. For more information, see *Global Parameters* on page 9.

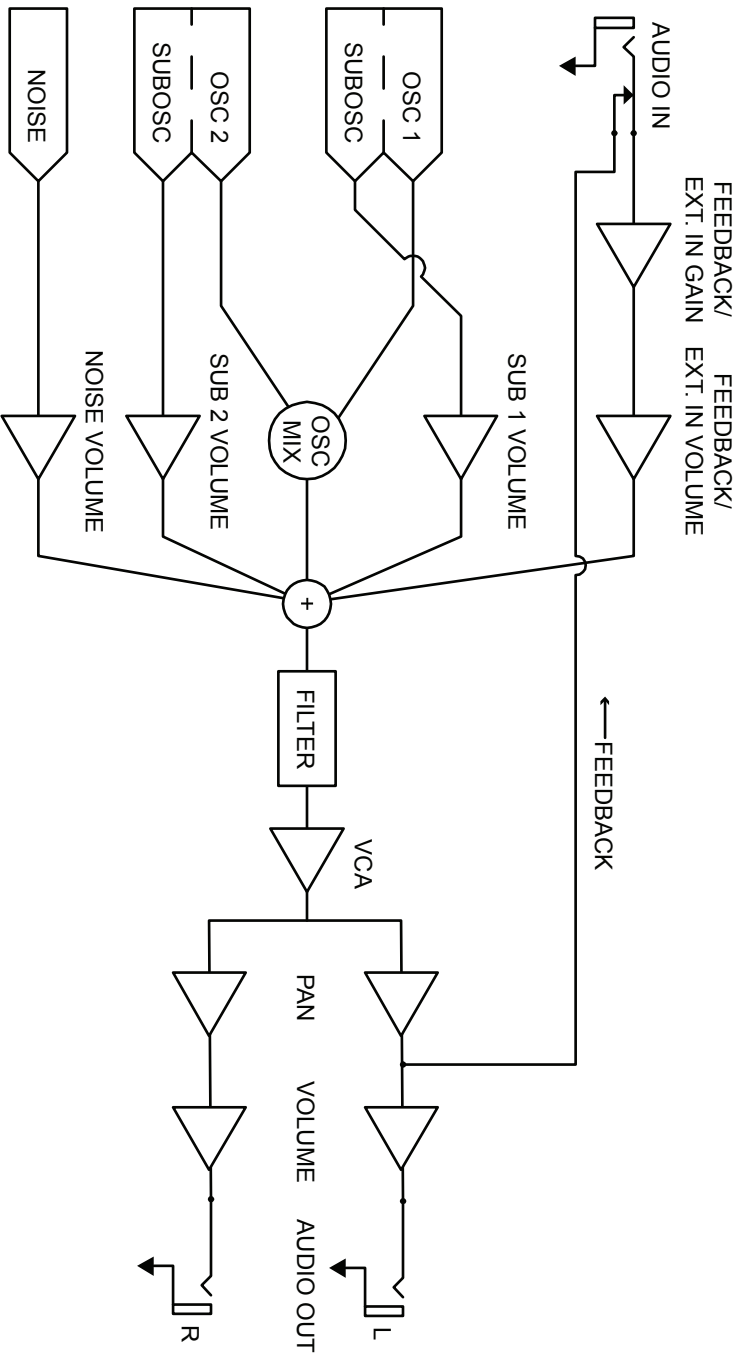

MOPHO SIGNAL FLOW DIAGRAM
 (Modulation routing omitted for clarity)

Global Parameters

Mopho's Global parameters affect all programs globally. Examples include MIDI channel and fine tune. To edit the Global parameters, hold down the Program switch until Global Parameter is displayed. The Param 1 knob changes the global parameter and Param 2 knob and increment and decrement buttons change the value.

Transpose: -12...+12—Master Transpose control, 0 is centered. Steps in semitones.

Fine Tune: -50...+50—Master Fine Tune control; 0 centered. Steps in cents (50 cents = 1/2 semitone).

MIDI Channel: ALL, 1...16—Selects which MIDI channel to send and receive data, 1 to 16. All receives on all 16 channels.

Clock: see table—Sets the clock status.

Display	MIDI Clock Setting
Internal	MIDI clock is neither sent nor received
MIDI Out	MIDI clock is sent
MIDI In	MIDI clock is received
Midi In/Out	MIDI clock is received and transmitted

MIDI Parameter Send: NRPN, CC, Off—Changes to the values of Mopho's front panel controls are transmitted via MIDI as Non-registered Parameter Number (NRPN) controllers or as Continuous Controllers (CC). Transmission of parameters can also be turned off. See *MIDI Implementation* on page 43 for details.

Note: NRPNs are the preferred method of parameter transmission, since they cover the complete range of all parameters, while CCs only handle the main parameters.

MIDI Parameter Receive: All, NRPN, CC, Off—Sets the method by which Mopho receives parameter changes via MIDI. As with transmission, NRPNs are the preferred method, though some controllers may only be able to send CCs.

MIDI Control: Off, On—When On, the synth will respond to MIDI controllers, including Pitch Wheel, Mod Wheel, Pedal, Breath, Volume, and Expression.

MIDI SysEx: Off, On—When On, the synth will respond to received MIDI SysEx messages, and will transmit them, when prompted, to the MIDI Out. See *Sysex Messages* on page 57 for details.

MIDI Out Select: Out, Thru—MIDI Out can be switched to MIDI Thru to daisychain multiple MIDI devices.

Poly Chain: Off, Out 1, Out 4, Out 5, Out 8, Out 12, Out 16—Used to expand the polyphony via the Poly Chain output and one or more DSI synths—Mopho, Tetra, or Prophet. See *Using Poly Chain* on page 38 for more information.

Local Control: Off, On—When on (the default), the keyboard and front panel controls directly affect Mopho. When off, the controls are transmitted via MIDI but do not directly affect the “local” synth (that is, Mopho). This is primarily useful for avoiding MIDI data loops that can occur with some external sequencers.

Audio Out: Stereo, Mono—Mopho defaults to stereo operation. When set to Mono, this parameter defeats all pan settings and modulation, effectively making each of the outputs a mono output.

PotMode: Relative, Passthru, Jump—The rotary controls on Mopho’s front panel are a mixture of “endless” rotary encoders and potentiometers or “pots.” The pots are identifiable by their lined knobs and the fact that they have about 330° of travel. There are three pot modes to determine how the synth reacts when the programmable parameters are edited. (Master volume is not programmable, so these modes don’t apply.)

When set to Relative, changes are relative to the stored setting. In Relative mode, the full value range is not available until either the minimum or maximum value and the respective lower or upper limit of the pot’s travel is reached.

For example, the Resonance parameter has a value range of 0 to 127. Let’s say the physical position of the Resonance pot is the equivalent of a value of 100. If you switch to a program that has a stored Resonance setting of 63 and turn the pot all the way up, it will only go to 90. To get to the maximum value of 127, you first have to turn down until the value is at the other extreme and the pot is at the limit of its travel (in this case, 0 and fully counter-clockwise, respectively).

In Passthru mode, turning the pot has no effect until after the edited value equals the preset value (that is, until the edited value “passes through” the stored value).

Jump mode uses an absolute value based upon the position of the pot when edited: turn a pot and the value jumps immediately from the stored value to the edited value.

Sustain: Norm +, Norm -, Arp +, Arp - —A momentary footswitch connected to Mopho’s Sustain input can be used either as a sustain pedal or to latch the

arpeggiator. Mopho can be configured for use with either normally open (+) or normally closed (-) footswitches. When set to Arp+ or Arp-, the footswitch will act as a sustain pedal when the Arpeggiator is off.

Pedal: see table—Sets the destination for the Pedal/CV input. Note that this input is heavily filtered for clean operation, so there is a limit to the speed it will respond to changes.

Display	Pedal Routing
FootCtrl	Routed to the Foot Control Modulation
Breath	Routed to the Breath Control Modulation
Expressn	Routed to the Expression Modulation
Volume	Controls Master Volume
LpFilter	Routed to the low-pass filter
LpF Half	Routed to the low-pass filter, but with half the range

The input will also accept control voltages in the range of 0 to 3.3 volts DC. It is protected against higher or negative voltages.

MIDI Pressure: Off, On—When On, the Mopho will respond to received MIDI pressure (aftertouch) messages and will transmit pressure from the keyboard to MIDI Out.

Velocity Curve: 1...4—Sets one of the four velocity curves for the keyboard to adjust the velocity response to your playing style.

Pressure Curve: 1...4—Sets one of the four pressure curves for the keyboard to adjust the aftertouch to your playing style.

Basic Patch—Press the Write button to load a basic patch into the edit buffer. The patch will not actually be written to the current program location unless intentionally written to memory in program mode using the Write button.

Reset Globals—Mopho does not have a full hardware reset, but select this parameter and press Write to reset the global parameters to their factory defaults.

Balance Tweak: -14...14—Adjusts the left/right output balance by approximately +/- 4 dB.

MIDI SysEx Dump: see table—Allows dumping of Programs in SysEx format via MIDI. Also enables the translation of Mopho Keyboard programs into formats readable by other DSI synths. Tetra's voice architecture and voice program parameters are basically the same as the Mopho Keyboard's. The desktop Mopho's Feedback Gain is not programmable, so some tweaking of that control may be necessary to match the sound to the keyboard. And the Prophet's

voice architecture is almost identical, but lacks the sub octave generators and feedback.

Display	MIDI Transmit Operation
Current Program	Dump current program
Current Bank	Dump all 128 programs in current bank
All Banks	Dump all programs in all 3 banks
Current Prog P08	Dump the current program in Prophet '08 format
CurrentProgMopho	Dump the current program in desktop Mopho format
CurrentProgTetra	Dump the current program in Tetra format
Current Bank P08	Dump the current bank in Prophet '08 format
CurrentBankMopho	Dump the current bank in desktop Mopho format
CurrentBankTetra	Dump the current bank in Tetra format

Press Write to start transmission. This feature is handy for saving Programs on a computer in SysEx format, or for sending them to another Mopho via a direct MIDI connection. The dumps include Program and Bank numbers, so when received, the programs will be stored in the same location.

Oscillators

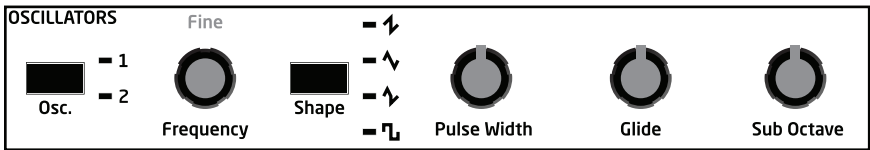

The Oscillators section contains the primary controls for Mopho’s two digitally controlled analog oscillators or DCOs. “Digitally controlled” does not mean the oscillators themselves are digital, just that the oscillators’ frequencies are under digital—rather than voltage—control. The advantage to that is that the tuning is exceptionally stable over a ten-octave range without having to compensate for variables like temperature. The audio signal path is still completely analog.

Oscillator Select—Choose oscillator 1, oscillator 2, of both. When both 1 and 2 are selected, changes made to the other oscillator parameters affect both oscillators.

Frequency: C 0...C 10—Sets the base oscillator frequency over a 10 octave range, from 8 Hz to 8KHz, stepping in semitones. C3 is middle C, the first octave is 0 (C0, C#0, etc.), the second octave is 1 (C1, C#1, etc.), and so on.

Fine Frequency: -50...+50—Fine tune control with a range of a quartertone up or down. Zero is centered. Steps are in cents (50 cents = 1/2 semitone).

Shape Select: Sawtooth, Triangle, Saw-Tri, Square, Off—Selects the oscillator waveshape. If none of the shapes are lighted, the oscillator is off.

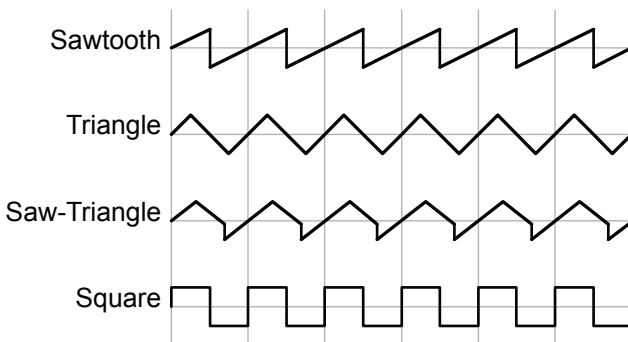

Pulse Width: 0...99—Sets the pulse width or *duty cycle* of the square wave. A value of 50 results in a true square wave with equal alternating high and low levels. Increasing or decreasing the value from 50 causes the waveshape to become asymmetrical. Lower values narrow the positive-going portion of the

wave, higher values widen it. At the extreme values, the pulse goes completely flat, which allows for some interesting possibilities with pulse width modulation.

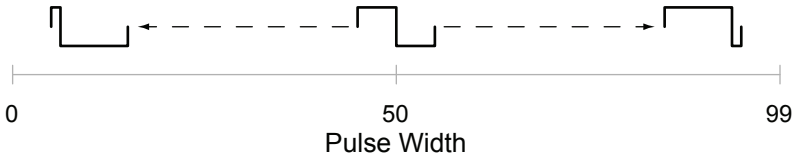

Glide: 0...127—Sets the oscillator glide (*portamento*) rate. Glide can be set independently for each oscillator. Low values are faster. See also “Glide Mode” in *Other Oscillator Parameters*.

Sub Octave: 0...127—Controls the level of a square wave pitched one octave below oscillator 1 or two octaves below oscillator 2.

Other Oscillator Parameters

These additional, less performance-oriented oscillator controls are found in the Miscellaneous Parameters section.

Oscillator Sync: Off, On—Turns oscillator hard sync on. With sync on, whenever oscillator 2 resets, oscillator 1 is forced to restart.

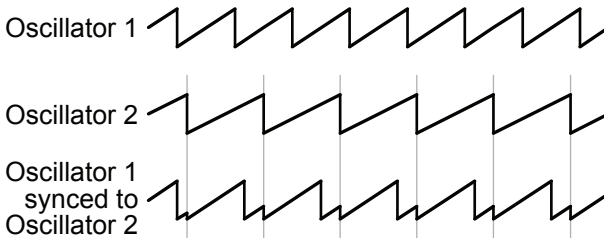

Tip: Try routing an envelope or the mod wheel to oscillator 1 frequency for the familiar sync sweep sound.

Oscillator 1 Keyboard Tracking: Off, On—Turns keyboard tracking off or on for oscillator 1.

Oscillator 2 Keyboard Tracking: Off, On—Turns keyboard tracking off or on for oscillator 2.

Oscillator Slop: 0..5—The amount of random oscillator frequency tuning slop. The analog oscillators in Mopho are very accurate, and will not drift. This works great for accurate sounds, and allows precise de-tuning. Oscillator Slop allows subtle amounts of frequency drift. For larger amounts, use a random LFO or white noise mod.

Glide Mode: FixRate, FixRate A, FixTime, FixTime A—Determines how the oscillators respond when Glide is on.

FixRate: The time to transition between notes varies with the interval between the notes; the greater the interval, the longer the transition time. The glide rate is fixed.

FixRate A: The same as FixRate, but glide is only applied when playing legato. That is, glide only occurs when a note is held until the next note is played. This effectively allows glide to be turned on and off from the keyboard.

FixTime: Glide is set to a fixed time, regardless of the interval between notes.

FixTime A: The same as FixTime, but glide only occurs when playing legato.

Pitch Wheel Range: 0...12—Sets the bend range, in semitones, of the pitch wheel. The setting is the range in the positive or negative direction. For example, a setting of 7 lets you bend a note up or down by a fifth.

Key Assign: Low Note, LowRetrig, HighNote, HighRetrig, LastNote, LastRetrig—Key Assign (aka note priority) determines what note gets priority when more than one note is played on the keyboard or via MIDI. Low-note priority is most common in vintage synths and is often used for playing trills by holding a note and repeatedly tapping a lower note. LowRetrig causes the envelopes to be retriggered with each keystroke. HighNote and HighRetrig are similar to the low note settings, except that the highest note is given priority. And LastNote and LastRetrig give priority to the last note played.

Mixer



The Mixer section balances the levels of the outputs of the Oscillators section and noise generator, and the Audio In/feedback loop before routing the summed signals to the low-pass filter.

Mix: 0...127—Mixes the outputs of oscillators 1 and 2 in varying amounts. A setting of 0 is equivalent to 100% oscillator 1 and 0% oscillator 2. A setting of 127 is just the opposite. A setting of 64 is a 50/50 mix of both oscillators.

Feedback Level/External Volume Level: 0...127—Left Out is normalled to Audio In. (The Voice Architecture diagram on page 8 details Mopho's signal routing.) If nothing is plugged in to the Audio In jack, increasing the Feedback Level causes more and more of the left output signal to be fed back into the audio path pre-filter. As the level increases, so does the effect of the feedback.

When an audio cable is inserted in Audio In, the feedback loop is broken and the audio is processed by Mopho's filter and VCA. In conjunction with the gain control, Audio In will accept a fairly wide range of signal levels from low-level sources like guitars to hotter, line-level signals. For more information, see *Using Audio In* on page 37.

Feedback Gain/External Input Gain: 0...127—Feedback Gain boosts the level of the feedback signal and is interactive with and dependent upon Feedback Volume. If Feedback Volume is set to 0, then Feedback Gain has no effect. (There is no feedback signal to boost.) However, Feedback Gain combined with higher levels of Feedback Volume can result in effects ranging from pleasing distortion to squirrely harmonic weirdness.

This control is also used to boost the gain of signals processed via Audio In. For line-level signals, additional gain is typically unnecessary. For low-level signals, such as those from passive guitars or basses, External Input Gain boosts the signal to more useful levels.

Noise: 0...127—Controls the volume of the white noise generator.

Filter

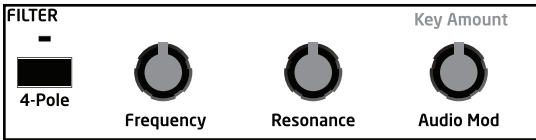

Mopho features a selectable 2- or 4-pole, low-pass filter.

4-Pole—Selects the filter configuration. When lighted, the filter is in 4-pole mode. A 4-pole, low-pass filter rolls off frequencies above the cutoff frequency at a slope of 24dB/octave. When the light is off, the filter is in 2-pole mode and has a slope of 12dB/octave and a more gradual rolloff of the higher frequencies.

Frequency: 0...164—Sets the base filter cutoff frequency over more than 13 octaves. This control steps in semitones when turned slowly, but smoothly controls the filter without steps when turned at a faster rate.

Resonance: 0...127—Emphasizes a narrow band of frequencies around the cutoff frequency. In 4-pole mode, high levels of resonance can cause the filter to self oscillate. In 2-pole mode, resonance is much more subtle.

Audio Mod: 0...127—Controls the amount of audio from oscillator 1 used to modulate the filter cutoff frequency. For filter-only audio, set the oscillator Mix to 127, oscillator 2 Shape to Off, and oscillator 1 Shape to the desired waveshape. This is useful for bell-like FM sounds. A wide range of sounds can also be made using Audio Mod with the oscillators routed normally through the filter.

Key Amount: 0...127—Sets the amount of modulation from the keyboard to the filter cutoff. A setting of 64 will step the filter in one semitone increments for each note, 32 would be quartertones, and so on.

Envelopes

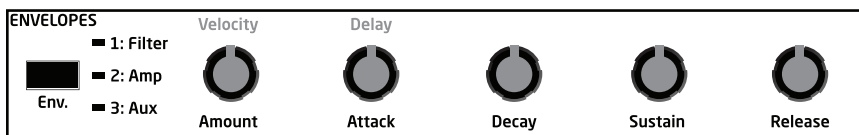

Mopho has three 5-stage (Delay + ADSR) envelope generators. Two are dedicated—one to the filter and the other to the amplifier—and the third is assignable to any modulation destination.

Envelope Select—Selects the envelope to edit. When all three are lighted, the other envelope parameters control all three envelopes simultaneously.

Amount: -127...127—Sets the amount of modulation from the envelope to the destination: filter, amplifier, or the selected destination for envelope 3. The modulation amount can be positive or negative, allowing for inverted envelope control. (For the VCA, the range is 0-127, since you can't have a negative gain on a VCA!)

Delay: 0...127—Sets a delay between the time the envelope is gated on and when the Attack portion actually begins

Attack: 0...127—Sets the attack time of the selected envelope(s).

Decay: 0...127—Sets the decay time of the selected envelope(s).

Sustain: 0...127—Sets the sustain time of the selected envelope(s).

Release: 0...127—Sets the release time of the selected envelope(s).

Velocity: 0...127—Sets the amount of key velocity used to modulate the envelope amount.

Other Envelope Parameters

There are two additional parameters for envelope 3 in the Miscellaneous Parameters section.

Envelope 3 Destination—Sets the destination modulated by envelope 3. See *Modulation Destinations* on page 33 for a list of possible destinations.

Envelope 3 Repeat: Off, On—When on, causes the delay, attack, decay, and sustain portions of Envelope 3 to loop for as long as the envelope is gated on. With repeat on, envelope 3 can even be used as a sort of complex LFO.

LFO

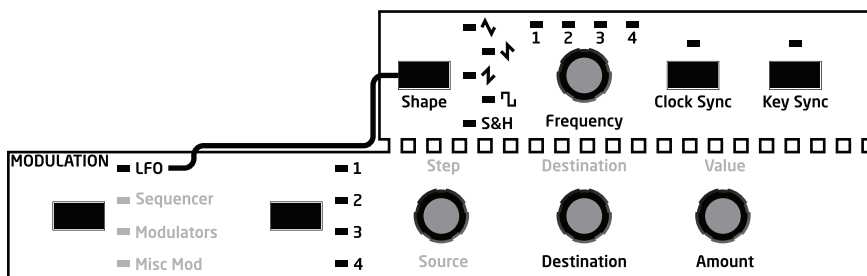

Mopho has four low frequency oscillators (LFOs). The LFOs can be free-running, synced to keystrokes, or synced to the sequencer and MIDI clock. To edit the LFO parameters, choose LFO in the Modulation section.

LFO Select: 1, 2, 3, 4—Chooses the LFO to edit.

Tip: The four numbered lights above the Frequency knob pulse at the frequency of the corresponding LFO. This can be a great aid in knowing which LFO to select for editing.

Destination—See *Modulation Destinations* on page 33 for a list of possible destinations.

Amount: 0...127—Sets the amount of LFO routed to the destination.

Shape: Triangle, Reverse Sawtooth, Sawtooth, Square, Sample and Hold—The waveshape of the LFO. Sample and Hold generates a random value that changes once per cycle.

Frequency: 0...150—Sets the LFO frequency. Speed ranges from slow (30 seconds) to very fast—at 90 (8 HZ, C-2) and above the speed steps in semitones, up to 150 (261 Hz, middle C).

Note: Some of the analog functions may not respond well to the fastest LFO speeds, due to speed limitations of the control voltages; but they will certainly generate some interesting sounds.

Clock Sync—When on, the LFO syncs to the sequencer and clock—either the internal clock or an external MIDI clock. When synced to the internal clock, BPM and Clock Divide both affect LFO frequency. When synced to an external clock, the external clock rate and Clock Divide affect the LFO frequency. Editing Frequency shows the values in the following table.

Display	Timing Sync
32 Steps	Sequence speed divided by 32; one LFO cycle takes 32 steps
16 Steps	Sequence speed divided by 16
8 Steps	Sequence speed divided by 8
6 Steps	Sequence speed divided by 6
4 Steps	Sequence speed divided by 4
3 Steps	Sequence speed divided by 3
2 Steps	Sequence speed divided by 2
1.5 Step	Sequence speed divided by 1.5
1 Step	One cycle per step
2/3 Step	Two cycles every three steps
1/2 Step	Two cycles per step
1/3 Step	Three cycles per step
1/4 Step	Four cycles per step
1/6 Step	Six cycles per step
1/8 Step	Eight cycles per step
1/16Step	Sixteen cycles per step

Tip: Use Clock Sync to modulate a parameter in time with the sequencer. For example, an LFO set to a triangle wave and a frequency of 16 steps can modulate the filter frequency for a sweep that is perfectly synced to the sequencer.

Key Sync—When on, the LFO is re-started each time a new note is played. Key Sync is set independently on each LFO.

Sequencer



For many musicians, the term sequencer has become synonymous with MIDI sequencer; that is, a computer-based application or dedicated hardware device for recording and playing back notes and performance gestures via MIDI. But sequencers were around long before MIDI. Mopho’s sequencer is much more like the original analog sequencers typically associated with modular synthesizer systems. The sequencer comprises four 16-step sequences that play in parallel. Each sequence can be routed to a chosen destination, and each step in a sequence can be set to a different value used to modulate that destination.

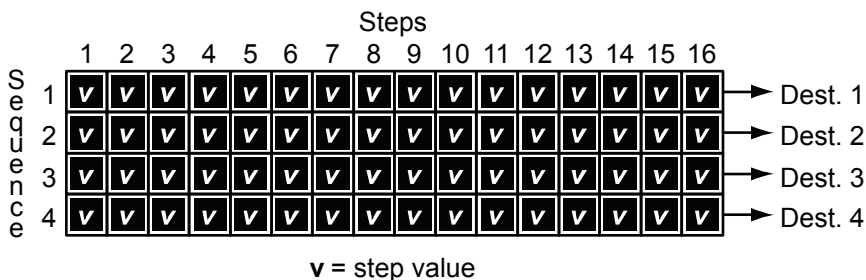

Strictly speaking, Mopho’s sequencer does not play notes, nor does it transmit MIDI data. If none of the sequence destinations are routed to oscillator frequency, the sequencer may not even affect the pitch. In Mopho terms, a sequence is just a series of events at timed intervals that changes the value of one of the synth’s parameters in discrete steps. Because the four sequences play in parallel, up to four parameters can be affected by each step, one per sequence. For the most part, the sequence destinations are the same as the modulation destinations, which is appropriate: a sequence is just another modulation source.

For each sequence step, the envelopes are gated on for half the step’s duration. The duration varies according to the BPM and Clock Divide settings (or the MIDI clock, if synced to an external source). The envelope settings of the current program ultimately determine how long each step plays, though, and longer (more legato) or shorter (more staccato) effects can be achieved by editing the envelope rates.

Mopho’s sequencer is a gated sequencer. That means it requires a note to be gated on—that is played from the keyboard, the Push It button, or via MIDI—in order for the sequencer to run. There is no dedicated start or play button and it

does not respond to MIDI start/stop/continue messages, but it can still sync to an external clock. Simply turn on the sequencer and then play and hold a note to start. Or use the Push It button's toggle feature to latch a note on with one push and release it with another; in this case, the Push It button is essentially a Start/Stop control.

Reset and Rest

Sequences have a maximum of 16 steps, but they can have fewer—from 1 to 15—using Reset. (Sequences of 16 steps reset automatically.) Reset appears immediately after the highest value setting for a step. Setting a step to Reset causes the sequence to jump back to the first step and continue playing.

Reset is set separately for each of the four sequences, so it must be set at the same step in all four sequences to shorten all the sequences equally. The following illustration shows an example in which all the sequences are eight steps in length.

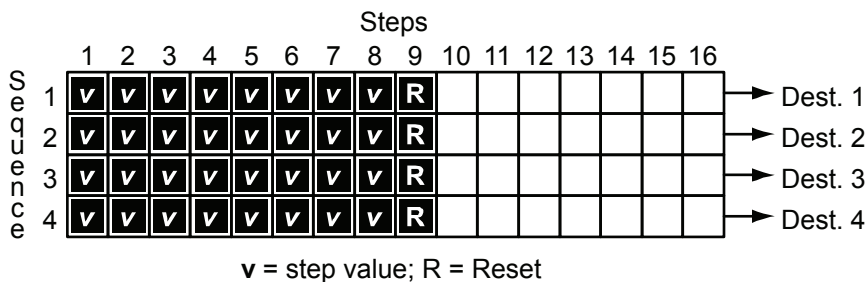

Tip: Using Reset while programming a sequence can be helpful. For example, when programming a specific melodic line, start by shortening the sequence to four or eight steps until those steps are set, and then gradually move the reset point to lengthen the loop until the desired number of steps is playing.

Sequences do not have to be the same length, however, which makes for some very interesting, less repetitive patterns, particularly when sequences are set to odd and even numbers of steps.

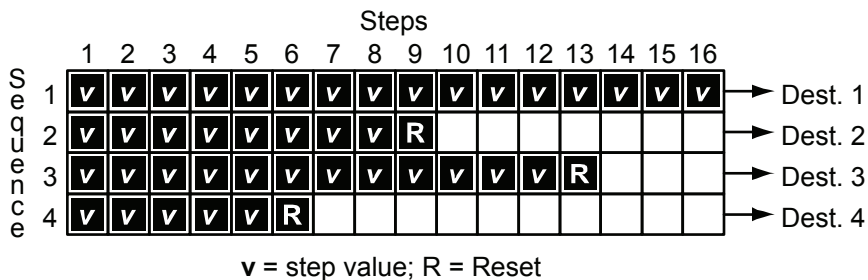

Sequence one has an additional value, Rest, that appears in the list after Reset. Rest prevents the envelopes from being gated by the corresponding step, so a rest in sequence one affects all four sequences. If the sequences are the same length, rests will occur in the same place in all four sequences as they loop. If the sequences are different lengths, the rests in sequence one apply to whatever the current step happens to be in sequences two through four, resulting in a more random-sounding pattern (which can be really cool). In the following example, sequence one is 16 steps long and rests occur at steps 2, 6, 9, and 12. However, sequence two is only eight steps long, so rests occur at steps 2 and 6 the first time it plays through and then at steps 1 and 4—the first time it repeats. As sequence two loops, the rests will continue in the same alternating pattern.

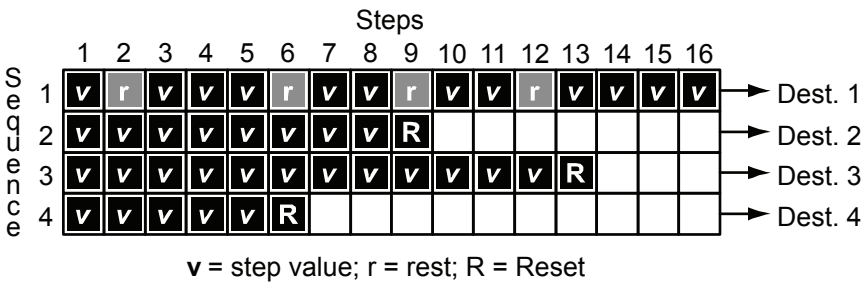

Programming the Sequencer

Programming the sequencer is easy, but there are a few things to consider before you start. Most importantly, what do you want the sequence to do and what modulation destinations will provide the results you're seeking? For example, is the sequencer going to control oscillator frequency? One sequence can control the frequency of both oscillators or one sequence can control oscillator 1 and another sequence can control oscillator 2 for harmonies or countermelodies. A typical application of the sequencer might have sequence one routed to the frequency of both oscillators, sequence two routed to filter cutoff, sequence three routed to filter resonance, and sequence four routed to amplifier envelope amount for accents. Many of the factory programs have sequences programmed, so you can refer to those to see how certain effects are being achieved.

To program a sequence:

1. Turn the sequencer on.
2. Choose Sequencer in the Modulation section.
3. Choose the sequence to program: 1, 2, 3, or 4.
4. Play a note to start the sequence playing.

To avoid having to hold a key down, set the Push It Mode (Misc. Parameters) to Toggle. Then use Push It to start and stop the sequencer. You may also want to change the Push It Note, the BPM, and the Clock Divide.

5. Choose a destination for the sequence.
6. Use the Step and Value controls to enter the desired values.

As the sequence loops, you will hear your edits.

7. Choose another sequence and follow the same basic steps until you're happy with the results.
8. Don't forget to write your edits to memory! Sequences are saved with the related program. Just press Write and then Yes to save the program and sequences.

More Sequencer Parameters

The previous section covers the basics of sequencer programming, but there are some additional parameters that affect the sound and user interaction with the sequencer.

Slew

In modular analog synthesizers, a *lag processor* or *slew limiter* is used to create a time-varying change—a smooth transition—between successive, discrete control voltage levels. The rate of change is called the *slew rate* and one common application is to create a glide (aka *portamento*) effect between notes.

Among the possible destinations for Mopho sequences two and four is a sequence-only parameter called Slew. Slew behaves a little differently from the other modulation destinations, in that it is not really a destination at all; instead, it affects the sequence above it. That is, if Slew is the chosen destination for sequence two, it controls sequence one, and Slew in sequence four controls sequence three.

In Mopho's sequencer, Slew sets the slew rate between the previous step's value and the current step's value when the step is gated on. Confused yet? This should help: let's say sequence one is routed to oscillator frequency and sequence two to Slew. Increasing the Slew value for step four will cause the oscillator frequency to glide from the step three value when step four is gated on. The higher the Slew value, the slower the slew rate. And the slew rate can be different for each step. But it's not just for oscillator glide. Slew can be applied to any of the destinations. For example, sequence three could be routed to filter cutoff with Slew in sequence four used to create a less abrupt transition from one step to the next.

Note: Depending upon the BPM and Clock Divide settings, the slew rate can actually exceed the time the envelopes are gated on, causing a step in the affected sequence to not reach its set value. For example, if Slew is applied to oscillator frequency, high Slew values may cause a step to sound flat or sharp. If that's not what you want, simply reduce the Slew value.

Sequencer Trigger Modes

The Sequencer Trigger mode determines how the sequencer reacts to triggers and what constitutes a trigger. Sequencer Trigger is found in the Miscellaneous Parameters section. The different modes are:

Normal—A note on, from either the local keyboard or via MIDI, causes the sequencer to play from the first step. The sequencer resets to step one each time a new note is played. Each sequence step gates the envelopes.

No Reset—As above, but the sequencer does not reset to step one for each note played. The sequencer is effectively free running.

No Gate—The keyboard gates the envelopes, but the sequencer does not. The sequencer resets to step one each time a new note is played.

NoGateNR—As above, but the sequencer does not reset to step one for each note played. Again, the sequencer is effectively free running.

Key Step—Striking any key or playing a note via MIDI advances the sequencer one step.

Audio In—Steps the sequencer and gates the envelopes when a signal at Audio In exceeds a preset threshold. External Volume does not affect the trigger and can be set at minimum. External Gain does boost the signal prior to the threshold detector and so will affect the triggering. And the level of the input signal will also have an effect.

Syncing an LFO to the Sequencer

One very useful way to modulate a parameter in sync with a sequence is using an LFO with Clock Sync. A setting of 16 Steps for LFO Frequency with a triangle wave selected and routed to the filter will provide a clean filter sweep over a 16-step sequence, perfectly in sync! This is much easier (and smoother) than manually programming a sequence to sweep the filter.

Modulators



Modulators lets you configure the modulation routing and amount for Mopho's four general-purpose modulation slots.

Since each Mopho modulation source has a single destination, the four general purpose modulators provide a way to send a mod source (such as a sequence or LFO) to additional destinations, with a different amount. There are also additional mod sources available here, such as Noise, allowing a wide variety of possibilities.

To configure a general-purpose modulation slot, select Modulators and choose the appropriate modulator: 1, 2, 3, or 4. Then use the Source, Destination, and Amount parameters to route the modulation as desired.

Source—Selects a modulation source. See *Modulation Sources* on page 32 for possible sources.

Amount: -127...+127—Sets the amount of modulation.

Destination—Selects a modulation destination. See *Modulation Destinations* on page 33 for a list of possible destinations.

Miscellaneous Modulators



There are certain standard controllers that Mopho consigns to dedicated modulators, things like mod wheel, pressure (aka aftertouch), and velocity. The most obvious benefits to doing this is it provides a shortcut to setting up commonly used controllers and it frees up the four general-purpose mod slots for other, more Mopho-specific applications. Select Misc Mod in the Modulation section to get started.

Source: Mod Wheel (MIDI CC#1), Pressure, Breath Controller (MIDI CC#2), Velocity, Foot Controller (MIDI CC#4)—Selects the modulation source. The source can also be changed using the 1-4 button, though the 1-4 LEDs do not change.

Note: There is a global parameter called Pedal for routing an expression pedal to various controllers or directly to the filter cutoff. See *Global Parameters* on page 9 for more information.

Destination—Chooses the destination to which the modulation source is routed. See *Modulation Destinations* on page 33 for a list of possible destinations.

Amount: -127...+127—Sets the amount of modulation.

Clock

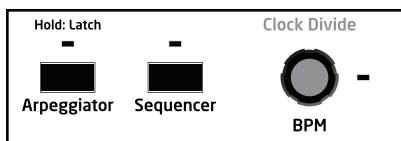

The Clock section contains the controls for the internal clock tempo and the note value for the arpeggiator and sequencer (and LFO, when Clock Sync is on). There are also switches to turn the arpeggiator and sequencer on and off.

Arpeggiator—Turns Mopho’s arpeggiator on and off. The tempo and note value are determined by the BPM and Clock Divide settings. Arpeggiator Mode is set in Miscellaneous Parameters. The different modes are:

Mode	Behavior
Up	Plays from lowest to highest note.
Down	Plays from highest to lowest note.
Up Down	Plays from lowest to highest and back to lowest.
Assign	Plays notes in the order keys were pressed.
Random	Randomly plays notes.
2 Octaves Up	Plays keyed notes and the same notes one octave higher, from lowest to highest.
2 Octaves Down	Plays keyed notes and the same notes one octave higher, from highest to lowest.
2 Octaves Up Down	Plays keyed notes and the same notes one octave higher, from lowest to highest and back to lowest.
2 Octaves Assign	Plays a keyed note, then the same note one octave higher, in the order keys were pressed.
2 Octaves Random	Randomly plays keyed notes and the same notes one octave higher.
3 Octaves Up	Plays keyed notes and the same notes one and two octaves higher, from lowest to highest.
3 Octaves Down	Plays keyed notes and the same notes one and two octaves higher, from highest to lowest.
3 Octaves Up Down	Plays keyed notes and the same notes one and two octaves higher, from lowest to highest and back to lowest.
3 Octaves Assign	Plays a keyed note, then the same note one and two octaves higher, in the order keys were pressed.
3 Octaves Random	Randomly plays keyed notes and the same notes one and two octaves higher.

Briefly hold the Arpeggiator switch down to latch arpeggiated notes. (The light will blink when latched.) Playing additional notes while latched adds them to the notes already playing.

The Arpeggiator can also be latched with a footswitch connected to the Sustain jack. See “Sustain” in *Global Parameters* on page 9.

The Arpeggiator (and Sequencer) can also sync to MIDI clock from an external sequencer or other device. See “Clock” in *Global Parameters* on page 9 for more information.

Sequencer—Turns Mopho’s gated sequencer on and off. See *Sequencer* on page 21 for more information.

BPM: 30...250—Sets the tempo for the sequencer in BPM (beats per minute). The accompanying light flashes on the beat. When syncing to an external MIDI clock source, the BPM control has no effect.

Clock Divide—Sets the note value for each sequencer or arpeggiator step relative to the BPM. Also affects the LFO frequency when LFO Clock Sync is on. Clock Divide works with both internal and external clock sources. The following table lists the Clock Divide values.

Display	Tempo	Timing Division
Half	BPM/2	Half note
Quartr	BPM	Quarter note
Eighth	BPM x 2	Eighth note
8 half	BPM x 2	Eighth note, half swing timing
8swing	BPM x 2	Eighth note, full swing timing
8 trip	BPM x 3	Eighth note triplets
16th	BPM x 4	Sixteenth note
16half	BPM x 4	Sixteenth note, half swing timing
16swing	BPM x 4	Sixteenth note, full swing timing
16trip	BPM x 6	Sixteenth note triplets
32nd	BPM x 8	Thirty-second note
32trip	BPM x 12	Thirty-second note triplets
64trip	BPM x 24	Sixty-fourth note triplets

Note: BPM is based on quarter notes, so clock divisions are relative to a quarter-note beat. For example, when Clock Divide is set to Eighth, two notes or steps will play per beat.

Miscellaneous Parameters

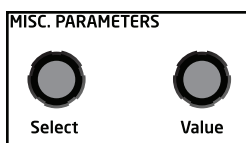

Miscellaneous Parameters groups together programmable parameters that do not conveniently fall into any obvious section or, if they do, are parameters that are less frequently used. They are important, but generally not required for performance.

Voice Volume: 0...127—Sets the volume of the current program to match volumes between programs.

Note: There is enough gain in the synth voice that with some settings, some mild clipping distortion may be heard. If this happens, try lowering the Voice Volume, and/or the Amp Envelope Amount (or Amp Envelope Velocity).

Name—The lower line of the LCD displays the name of the current program. Use the Name parameter to edit the name. When Name is selected, a character blinks to indicate that it is active. To edit the character, use the Value knob, the Param 2 knob, or the +/Yes or -/No switches. Use the Param 1 knob to edit another character.

Oscillator Sync, Keyboard Tracking, Slop, Glide Mode, Pitch Wheel Range, and **Key Assign** are described under “Other Oscillator Parameters” in *Oscillators* on page 14.

Sequence Trigger is described under “Sequence Trigger Modes” in *Sequencer* on page 25.

Arpeggiator Mode is part of the **Arpeggiator** description in *Clock* on page 28.

Envelope 3 Destination and **Envelope 3 Repeat** are described under “Other Envelope Parameters” in *Envelopes* on page 18.

VCA Level: 0...127—Sets a base level for the VCA (Voltage Controlled Amplifier). This essentially allows the VCA to be bypassed for programs that drone.

Note: If VCA Level is on full, Envelope Amount has no effect. For normal operation from the keyboard, VCA Level should be set to 0. For

droning sounds, or possibly when using Mopho to process external audio, turn the VCA Level up.

Push It Mode: Normal, Toggle, Audio In—When set to Normal, Push It responds like a key: press it and a note plays, release it and the note ends. But when set to Toggle, Push It turns the note on with one press and off with a second press. This is handy for making a note drone or for latching a gated sequence on.

Somewhat related, the Audio In setting will generate a gate from Audio In. When the audio signal gets above a certain fixed level, the gate will go on. When it drops below that level, the gate will go off.

Push It Note: C0...C10—Sets the note that plays when Push It is pressed.

Push It Velocity: 0...127—Sets the MIDI note-on velocity.

Unison On/Off—Why does a monophonic synthesizer need a Unison switch? Because it might be poly chained to another DSI synth, the Tetra being the obvious choice—five voices of analog power, in a very small footprint!

Unison Mode—Sets how voices are allocated and tuned when unison is on.

Display	Mode
1 Voice	Classic, two oscillator, monophonic mode
All Voices	All available voices in unison
AllDetune1-3	All available voices in unison with increasing levels of detuning among the voices

Modulation Sources

Display	Source
Off	No source selected
Sequence1	Sequence 1
Sequence2	Sequence 2
Sequence3	Sequence 3
Sequence4	Sequence 4
LFO 1	LFO 1
LFO 2	LFO 2
LFO 3	LFO 3
LFO 4	LFO 4
Filt Env1	Filter Envelope
VCA Env 2	Amp (VCA) Envelope
Envelope3	Envelope 3
PitchBend	Pitch Bend
Mod Wheel	Mod Wheel
Pressure	Pressure (Aftertouch)
MidBreath	MIDI - Breath Controller
Midi Foot	MIDI - Foot Controller
Midi Exp	MIDI - Expression
Velocity	Keyboard Note Velocity
KeyNumber	Keyboard Note Number
Noise	Noise
EnvFollow	Audio In Envelope Follower
Peak Hold	Audio In Peak Hold

Modulation Destinations

Display	Destination
Off	No destination selected
Osc 1 Freq	Oscillator 1 Frequency
Osc 2 Freq	Oscillator 2 Frequency
OscAllFreq	Oscillator 1 and 2 Frequency
Osc Mix	Oscillator Mix
NoiseLevel	Noise Level
Osc1 Pulsw	Oscillator 1 Pulse Width
Osc2 Pulsw	Oscillator 2 Pulse Width
Osc All PW	All Oscillators Pulse Width
Low Pass	Lowpass Filter Frequency
Resonance	Resonance
Audio Mod	Audio Mod Amount
VCA Level	VCA Amount
Output Pan	Stereo Pan Position
LFO 1 Freq	LFO 1 Frequency
LFO 2 Freq	LFO 2 Frequency
LFO 3 Freq	LFO 3 Frequency
LFO 4 Freq	LFO 4 Frequency
LFOAllFreq	All LFO Frequencies
LFO 1 Amt	LFO 1 Amount
LFO 2 Amt	LFO 2 Amount
LFO 3 Amt	LFO 3 Amount
LFO 4 Amt	LFO 4 Amount
LFOAll Amt	All LFO Amounts
Env 1 Amt	Envelope 1 Amount (Level)
Env 2 Amt	Envelope 2 Amount (Level)
Env 3 Amt	Envelope 3 Amount (Level)
EnvAll Amt	All Envelope Amounts (Levels)
Env1Attack	Envelope 1 Attack Rate
Env2Attack	Envelope 2 Attack Rate
Env3Attack	Envelope 3 Attack Rate
EnvAll Att	All Envelope Attack Rates
Env1 Decay	Envelope 1 Decay Rate
Env2 Decay	Envelope 2 Decay Rate
Env3 Decay	Envelope 3 Decay Rate
EnvAll Dec	All Envelope Decay Rates
Env1Releas	Envelope 1 Release Rate
Env2Releas	Envelope 2 Release Rate
Env3Releas	Envelope 3 Release Rate
EnvAll Rel	All Envelope Release Rates
Mod 1 Amt	Modulator 1 Amount
Mod 2 Amt	Modulator 2 Amount

Mod 3 Amt	Modulator 3 Amount
Mod 4 Amt	Modulator 4 Amount
Fback Vol	Feedback Volume
Sub Osc 1	Sub Oscillator 1 Level
Sub Osc 2	Sub Oscillator 2 Level
Fback Gain	Feedback Gain
Slew	Sequencer Slew*

*Appears as a destination in sequences 2 and 4 only.

Using USB

Mopho's USB 2.0 port enables bidirectional MIDI communication with a computer. A MIDI interface and MIDI cables are not necessary, just a USB cable. Mopho is a Class Compliant USB device. That means it does not require any additional drivers to be installed to communicate with a Mac or Windows computer.

Mopho transmits and receives MIDI data via USB, but does not transmit audio.

Note: MIDI In and USB should not be used at the same time, as overlapping messages from different sources may cause Mopho to respond unpredictably. MIDI Out and USB can be used at the same time and transmit the same data. Poly Chain Out is an independent MIDI bus and can be used regardless of the “normal” MIDI connection.

USB Notes

Under Mac OS X, Mopho will appear as a MIDI port when connected via USB and can be configured using the Mac's Audio MIDI Setup application (typically found in Applications/Utilities).

Under Windows XP, the first time Mopho is connected via USB, the “Found new hardware” alert appears and Mopho is automatically installed—somewhat misleadingly—as “USB Audio Device.” If there is already another Class Compliant USB device installed, Mopho will show up as “USB Audio Device(2)” (or 3 or 4 or...).

To determine which USB Audio Device is Mopho:

1. Open the System Control Panel
2. Click the Hardware tab.
3. Click Device Manager.
4. Expand “Sound, video, and game controllers.”
5. Right-click any “USB Audio Device” and choose Properties from the pop-up menu.

The General tab of the USB Audio Device Properties window displays the Device Type, Manufacturer, and Location. For Mopho, the Location should read “Location *n* (DSI Mopho).”

Windows Vista and Windows 7 behave the same as XP, but the device name is DSI Mopho rather than USB Audio Device.

In Windows, if you unplug the USB cable and plug it back in while a program has the Mopho port open, you may have to resync. That usually means going to the USB Audio Device (or DSI Mopho) Properties, as in the procedure above, and clicking OK. If Mopho is no longer listed in the Device Manager under “Sound, video, and game controllers,” power Mopho down and back up again while it is connected via USB. It should be detected on power up.

Using Audio In

The Audio In jack on Mopho's rear panel can take audio from a variety of sources, including line level signals and guitars. But what happens to it once its inside and how do you get it out again? Simply plugging a guitar in does not mean you will actually hear something when you play it.

Mopho's basic audio signal path goes from oscillators to mixer to filter to VCA. Audio In goes into the mixer. (Mopho has no pitch detection capability, so the oscillators cannot track the pitch of the incoming signal. A pitch-to-MIDI converter is needed to play the synth from a guitar.) So the External Volume level must be up for Audio In to work. But you probably still won't be able to hear it. There are two potential obstacles in the audio signal path: the filter and the VCA. If the filter's cutoff frequency is turned down, audio does not pass through. And if the VCA Level (Misc. Parameters) is down or nothing is gating the amplifier envelope, no audio will pass through the VCA. The two most obvious ways around the VCA are to turn the VCA Level up, essentially bypassing the VCA, or use the sequencer to gate the envelopes. (You could also use the keyboard to gate the envelopes, but then you start to run out of hands!)

There are two programs in Bank 1 demonstrating ways in which to use Audio In. Ext In Env Filt (Bank 1 Program 127) is a simple envelope filter. VCA Level is turned all the way up, allowing the audio to pass through the VCA. Both oscillators are turned off; if they were on, you'd hear them droning because VCA Level is turned up. Modulator 1 Source is set to EnvFollow (envelope follower) and the destination is set to Low Pass (the filter). That means the level of the incoming audio controls the filter's cutoff frequency. Resonance is also set at a moderate level, so you should hear a nice, squirty, blat at the peaks. For low-level signals like a passive guitar or bass, you will probably need to turn External Gain up to make it work properly.

The other program, Ext In Sequence (Bank 1 Program 128) uses the sequencer to gate the envelopes for a pulsing, rhythmic effect. Press Push It! to latch the sequencer on. Noise level is up, providing little percussive noise bursts. The oscillators are still turned off. LFO 1 is synced to the sequencer and controlling the VCA's output panning. Sequence 1 is controlling filter cutoff. Again, you may need to turn up External Gain for low-level signals. You can have a ton of fun playing with just Mopho and patches like this, but if you sync to an external sequencer or delay or both, things really get interesting!

Using Poly Chain

Mopho's Poly Chain output enables it to be connected to other DSI synths for up to 17-voice polyphony. Products that can be chained include the Tetra, Prophet '08 (module and keyboard), desktop Mopho, and a second keyboard Mopho. It will not chain with the Evolvers and Poly Evolvers due to the different voice structures.

Note data from Mopho's keyboard is intelligently processed so that, when one synth's maximum polyphony is reached, additional notes are passed through the Poly Chain output and routed to the next synth in the chain. All that is required is a single MIDI cable for each of the chained synths and a mixer for combining the audio outputs.

Tetra is the best candidate for poly chaining with the Mopho Keyboard; the voice architecture and programmable parameters are identical. The desktop Mopho or Prophet '08 will also work, but there are some differences between these synths and the Mopho Keyboard:

- The desktop Mopho's Feedback Gain control is not programmable and may need to be tweaked manually to match the Mopho Keyboard. Programs that don't use feedback sound the same on both models.
- The Prophet does not have feedback or sub octave generators.
- Both the Prophet and Tetra have two layers for stacked and split programs; Mopho does not. When Prophet or Tetra programs are loaded into Mopho, layer B is ignored.

You should have the same programs loaded into all the chained synths. The easiest way to do that is to use the Dump command in the Global menu to dump the programs via MIDI from one synth to the other(s).

The Poly Chain parameter is in the global menu. On the Mopho Keyboard, set Poly Chain to the number of additional voices that will be chained: Out 1 (for poly chaining a Mopho), Out 4, Out 5, Out 8, Out 12, or Out 16. Refer to the illustration on page 40 for examples of the Poly Chain settings on the slave units.

You can now virtually ignore the slave unit or units, since the controls on the master will control all units as if they were a single synth. This includes saving a program; if you save an edited program on the master, it will also save the program on the slave(s).

Note: If syncing to an external MIDI clock, set MIDI Clock (Global menu) on the master and any intermediate units to MIDI In/Out. Set the last instrument in the chain to MIDI In.

When Poly Chain is set to Off, the Poly Chain MIDI out jack simply duplicates the MIDI out jack.

Some of the Poly Chain configurations possible with Mopho, Tetra, and the Prophet '08.

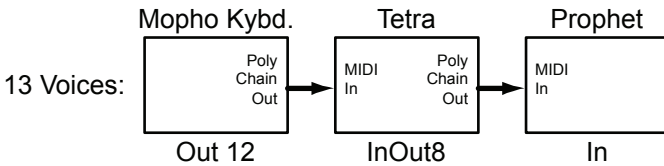
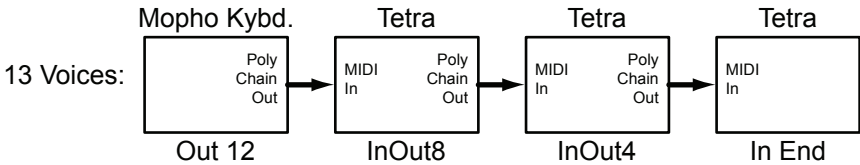
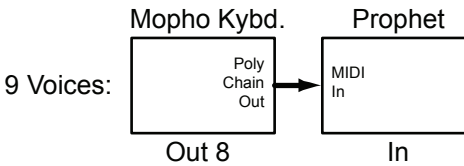
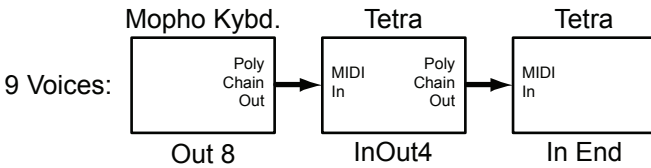
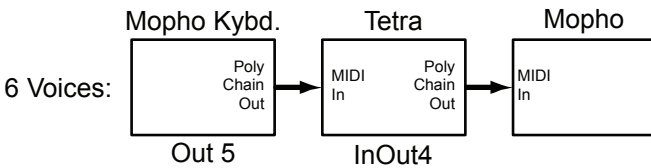
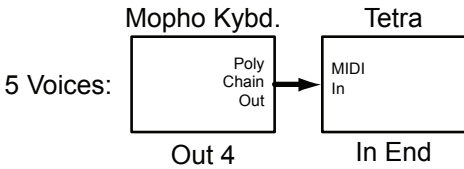
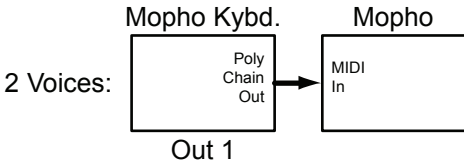

Support

Troubleshooting

Here are a few suggestions for resolving problems that may occur.

The sequencer has stopped running.

Make sure Clock in the Global menu is set to Internal.

Some of the programs sound different.

Check the Mod Wheel position. The Mod Wheel can do a lot more than just add vibrato. Also, some of the programs use the sequencer to shape the sound so make sure Clock in the Global menu is set to Internal.

There is a ground hum in the audio output.

USB can cause ground loops, so try to resolve any grounding issues between the computer and Mopho. Or use MIDI, which is opto-isolated.

Mopho is behaving erratically.

This is almost always caused by a MIDI data loop. Make sure that any MIDI Thru functionality is turned off on the MIDI interface/hardware or in the MIDI software application (sequencer or whatever). Disconnect all Mopho's MIDI connections—MIDI and USB cables—and see if the problem persists. You can also monitor the MIDI traffic with MIDI Monitor (Mac OS) or MIDI-OX (Windows) to see if Mopho is being overrun with duplicate messages.

An oscillator or the filter sounds strange or out of tune.

Hold Compare and press Osc Shape to run the calibration routine.

Note: It is not necessary to run the calibration routine on a regular basis. You should only run it if you are experiencing problems.

Still experiencing a problem with Mopho? Reset the Global parameters (in the Global menu).

Contacting Technical Support

If you are still having a problem with Mopho, contact Technical Support at support@davesmithinstruments.com. Please include your Mopho's serial number, the version of the operating systems (Main and Voice displayed on startup), and the purchase date.

Note: If you have not already reset the Global parameters and run the calibration routine (see Troubleshooting above), you should do it before contacting Technical Support. It's probably the first thing they'll ask you to do.

Warranty Repair

Dave Smith Instruments warrants that Mopho will be free from defects in materials and/or workmanship for 1 year from the date of purchase. Please register your product online at www.davesmithinstruments.com to establish the date of purchase. (This is not a requirement for warranty service, but it will help expedite the process.)

Please contact support@davesmithinstruments.com to determine the best course of action for getting your Mopho repaired. For your own protection, as well as ours, **please do not return any product to Dave Smith Instruments without a return authorization (RA) number.** To issue an RA number, Technical Support needs:

- Your name
- Your return address
- Your email address
- A phone number where you can be reached
- Your Mopho's serial number
- The date of purchase and where purchased

If you need to return your instrument for repair, you are responsible for getting it to DSI. We highly recommend insuring it and packing in the original packaging. Damage resulting from shipping a product with insufficient packaging is not covered by warranty.

MIDI Implementation

Mopho receives MIDI data according to the mode controls under GLOBAL. In addition, there is interaction between some of the Program parameters that determine the overall response of Mopho to MIDI data.

Following are the Global parameters that affect response to MIDI:

MIDI Channel: ALL, 1...16 — Selects the MIDI channel to send and receive data, 1 to 16. All receives on any channel.

Clock: see table — Selects the MIDI clock status as follows:

Display	MIDI Clock Setting
Internal	MIDI clock is neither sent nor received
MIDI Out	MIDI clock is sent
MIDI In	MIDI clock is received
MIDIIn/Out	MIDI clock is received and transmitted

MIDI Parameter Send: NRPN, CC, Off — Changes to the values of Mopho's front panel controls are transmitted via MIDI as Non-registered Parameter Number (NRPN) controllers or as Continuous Controllers (CC). Transmission of parameters can also be turned off.

MIDI Parameter Receive: All, NRPN, CC, Off — Sets the method by which Mopho receives parameter changes via MIDI. As with transmission, NRPNs are the preferred method, though some controllers may only be able to send CCs.

MIDI Control: Off, On — When On, the synth will respond to MIDI controllers, including Pitch Wheel, Mod Wheel, Pedal, Breath, Volume, and Expression.

MIDI SysEx: Off, On — When On, the synth will respond to received MIDI SysEx messages, and will transmit them, when prompted, to the MIDI Out.

Additional Continuous Controllers (CCs) Transmitted/Received

The following table details how CCs are mapped onto Mopho's controls. They are transmitted when MIDI Parameter Send is set to CC in Global, and recognized when received when MIDI Parameter Receive is set to either CC or All in Global.

Parameter	CC#
Osc 1 Frequency	20
Osc 1 Freq Fine	21
Osc 1 Shape	22
Glide 1	23
Osc 2 Frequency	24
Osc 2 Freq Fine	25
Osc 2 Shape	26
Glide 2	27
Osc Mix	28
Noise Level	29
Sub Oscillator 1	30
Sub Oscillator 2	31
Filter Frequency	102
Resonance	103
Filter Key Amt	104
Filter Audio Mod	105
Filter Env Amt	106
Filter Env Vel Amt	107
Filter Delay	108
Filter Attack	109
Filter Decay	110
Filter Sustain	111
Filter Release	112
VCA Level	113
Amp Env Amt	115
Amp Velocity Amt	116
Amp Delay	117
Amp Attack	118
Amp Decay	119
Amp Sustain	75
Amp Release	76

Parameter	CC#
Env 3 Destination	85
Env 3 Amt	86
Env 3 Velocity Amt	87
Env 3 Delay	88
Env 3 Attack	89
Env 3 Decay	90
Env 3 Sustain	77
Env 3 Release	78
BPM	14
Clock Divide	15

NRPN Messages

The Non-Registered Parameter Number (NRPN) MIDI messages are used to transmit and receive both global and program parameters. They are transmitted when MIDI Parameter Send is set to NRPN in Global, and received when MIDI Parameter Receive is set to either NRPN or All in Global.

The messages are handled in standard MIDI format using the NRPN CC commands in running status byte format. Below is the format used for transmitting a NRPN parameter:

Transmitted NRPN Messages	
---------------------------	--

Status	Description
1011 nnnn	Control Change
0110 0011	NRPN parameter number MSB CC
0vvv vvvv	Parameter Number MSB
0110 0010	NRPN parameter number LSB CC
0vvv vvvv	Parameter Number LSB
0000 0110	NRPN parameter value MSB CC
0vvv vvvv	Parameter value MSB
0010 0110	NRPN parameter value LSB CC
0vvv vvvv	Parameter value LSB

The parameter number can be found in the two tables below, one for Global parameters, and the other for Program parameters. The parameter numbers and the parameter values are broken into two 7-bit bytes for MIDI transmission; the LSB has the seven least-significant bits, and the MSB has the seven most-significant bits, though in most cases the MSB will be zero or one, and never more than two.

When receiving an NRPN, all messages do not necessarily need to be transmitted, since the synth will track the most recent NRPN number, though it is usually good practice to send the entire message above.

Once an NRPN is selected, the synth will also respond to NRPN Data Increment and Decrement commands, which some controllers utilize. Finally, it responds to one RPN (Registered Parameter Number) command, the RPN/NRPN Reset command, which can be handy for resetting the currently selected parameter to a known state.

Received NRPN Messages

Status	Second	Third	Description
1011 nnnn	0110 0011	0vvvvvvv	NRPN parameter number MSB CC
1011 nnnn	0110 0010	0vvvvvvv	NRPN parameter number LSB CC
1011 nnnn	0000 0110	0vvvvvvv	NRPN parameter value MSB CC
1011 nnnn	0010 0110	0vvvvvvv	NRPN parameter value LSB CC
1011 nnnn	0110 0000	0xxxxxxx	NRPN parameter value Increment
1011 nnnn	0110 0001	0xxxxxxx	NRPN parameter value Decrement
1011 nnnn	0010 0101	01111111	NRPN parameter number MSB CC - Reset NRPN parameter number (when both MSB and LSB received)
1011 nnnn	0010 0100	01111111	NRPN parameter number LSB CC - Reset NRPN parameter number (when both MSB and LSB received)

Global Parameter Data

The following table shows the Global data that is sent and received on global parameter dumps, and the corresponding NRPN number when sent/received individually.

Param	NRPN	Range	Description
0	384	0 - 24	Master Transpose; 0 = -12 semitones (1 octave), 12 = 0 (no transpose), and 24 = +12 semitones.
1	385	0 - 100	Master Fine Tune; 0 = -50 cents, 50 = 0 (centered), 100 = + 50 cents
2	386	0 - 16	MIDI Channel; if = 0, data received on all MIDI channels. Otherwise = channel number 1 - 16.
3	388	0 - 3	MIDI clock select* 0 Use Internal clock, don't send MIDI clock 1 Use Internal clock, send MIDI clock 2 Use MIDI clock In 3 Use MIDI clock In, and retransmit MIDI clock out
4	390	0 - 2	Parameter Send*: 0 NRPN 1 CC 2 Off
5	391	0 - 3	Parameter Receive†: 0 All 1 NRPN only 2 CC only 3 Off
6	394	0 - 1	MIDI Controller Send/Receive Off/On
7	395	0 - 1	MIDI Sysex Send/Receive Off/On

Param	NRPN	Range	Description
8	406	0 - 1	MIDI Out Select*: 0 MIDI Out 1 MIDI Thru
9	387	0 - 6	Poly Chain*: 0 Off 1 Out 1 2 Out 4 3 Out 5 4 Out 8 5 Out 12 6 Out 16
10	389	0 - 1	Local Control* Off/On
11	400	0 - 1	Audio Outputs: 0 Stereo 1 Mono
12	404	0 - 2	Pot Mode: 0 Relative 1 PassThru 2 Jump
13	397	0 - 3	Damper Polarity: 0 Sustain, normally open 1 Sustain, normally closed 2 Arpeggiator latch, normally open 3 Arpeggiator latch, normally closed
14	396	0 - 5	Pedal Destination: 0 Foot Control 1 Breath Control 2 Expression 3 Volume 4 Filter Frequency 5 Filter Frequency/2
15	393	0 - 1	MIDI Pressure Send/Receive Off/On
16	399	0 - 3	Pressure Curve
17	398	0 - 3	Velocity Curve
18			Basic Patch
19			Reset Globals
20	403	0 - 28	Balance Tweak*

*Received, but not sent.

†Sent, but ignored when received.

Program Parameter Data

The following table lists Mopho's voice parameters. The parameter number in the program and edit buffer dumps are different than the NRPN numbers as seen; this was to maintain NRPN compatibility with the Prophet '08 as much as possible.

Param	NRPN	Range	Description
0	0	0 - 120	Oscillator 1 Frequency, 0 - 120 in semitones (10 octave range)
1	1	0 - 100	Oscillator 1 Fine Tune; 0 = -50 cents, 50 = 0 (centered), 100 = + 50 cents
2	2	0-103	Oscillator 1 Shape 0 Oscillator Off 1 Sawtooth 2 Triangle 3 Sawtooth/triangle mix 4 - 103 Pulse Wave, Pulse width 0 - 99
3	3	0 - 127	Oscillator 1 Glide
4	4	0 - 1	Oscillator 1 Keyboard Off/On
5	114	0 - 127	Sub Oscillator 1 Level
6	5	0 - 120	Oscillator 2 Frequency, 0 - 120 in semitones (10 octave range)
7	6	0 - 100	Oscillator 2 Fine Tune; 0 = -50 cents, 50 = 0 (centered), 100 = + 50 cents
8	7	0 - 103	Oscillator 2 Shape 0 Oscillator Off 1 Sawtooth 2 Triangle 3 Sawtooth/triangle mix 4 - 103 Pulse Wave, Pulse width 0 - 99
9	8	0 - 127	Oscillator 2 Glide
10	9	0 - 1	Oscillator 2 Keyboard Off/On
11	115	0 - 127	Sub Oscillator 2 Level
12	10	0 - 1	Sync off/on
13	11	0 - 3	Glide Mode: 0 fixed rate 1 fixed rate auto 2 fixed time 3 fixed time auto
14	12	0 - 5	Oscillator Slop
15	93	0 - 12	Pitch Bend Range
16	13	0 - 127	Oscillator 1 - 2 Mix
17	14	0 - 127	Noise Level
18	116	0 - 127	Feedback/External Audio Volume
19	110	0 - 127	Feedback/External Audio Gain
20	15	0 - 164	Filter Frequency, steps in semitones
21	16	0 - 127	Resonance

22	17	0 - 127	Filter Keyboard Amount
23	18	0 - 127	Filter Audio Modulation
24	19	0 - 1	Filter Poles 0: 2-pole; 1: 4-pole
25	20	0 - 254	Filter Envelope Amount; -127 to +127
26	21	0 - 127	Filter Envelope Velocity Amount
27	22	0 - 127	Filter Envelope Delay
28	23	0 - 127	Filter Envelope Attack
29	24	0 - 127	Filter Envelope Decay
30	25	0 - 127	Filter Envelope Sustain
31	26	0 - 127	Filter Envelope Release
32	27	0 - 127	VCA Initial Level
33	30	0 - 127	VCA Envelope Amount
34	31	0 - 127	VCA Envelope Velocity Amount
35	32	0 - 127	VCA Envelope Delay
36	33	0 - 127	VCA Envelope Attack
37	34	0 - 127	VCA Envelope Decay
38	35	0 - 127	VCA Envelope Sustain
39	36	0 - 127	VCA Envelope Release
41	29	0 - 127	Voice Volume
42	37	0 - 166	LFO 1 Frequency; 0 - 150 un-synced frequencies 151 Sequence speed divided by 32 152 Sequence speed divided by 16 153 Sequence speed divided by 8 154 Sequence speed divided by 6 155 Sequence speed divided by 4 156 Sequence speed divided by 3 157 Sequence speed divided by 2 158 Sequence speed divided by 1.5 159 One cycle per step 160 Two cycles per three steps 161 Two cycles per step 162 Three cycles per step 163 Four cycles per step 164 Six cycles per step 165 Eight cycles per step 166 Sixteen cycles per step
43	38	0 - 4	LFO 1 Shape 0 Triangle 1 Reverse Sawtooth 2 Sawtooth 3 Pulse (square) 4 Random
44	39	0 - 127	LFO 1 Amount
45	40	0 - 47	LFO 1 Mod Destination; See Modulation Destination list below
46	41	0 - 1	LFO 1 Key Sync Off/On
47	42	0 - 166	LFO 2 Frequency; same as LFO 1
48	43	0 - 4	LFO 2 Shape; same as LFO 1
49	44	0 - 127	LFO 2 Amount

50	45	0 - 47	LFO 2 Mod Destination; See Modulation Destination list below
51	46	0 - 1	LFO 2 Key Sync Off/On
52	47	0 - 166	LFO 3 Frequency; same as LFO 1
53	48	0 - 4	LFO 3 Shape; same as LFO 1
54	49	0 - 127	LFO 3 Amount
55	50	0 - 47	LFO 3 Mod Destination; See Modulation Destination list below
56	51	0 - 1	LFO 3 Key Sync Off/On
57	52	0 - 166	LFO 4 Frequency; same as LFO 1
58	53	0 - 4	LFO 4 Shape; same as LFO 1
59	54	0 - 127	LFO 4 Amount
60	55	0 - 47	LFO 4 Mod Destination; See Modulation Destination list below
61	56	0 - 1	LFO 4 Key Sync Off/On
62	57	0 - 47	Envelope 3 Mod Destination; See Mod Destination list below
63	58	0 - 254	Envelope 3 Amount; -127 to +127
64	59	0 - 127	Envelope 3 Velocity Amount
65	60	0 - 127	Envelope 3 Delay
66	61	0 - 127	Envelope 3 Attack
67	62	0 - 127	Envelope 3 Decay
68	63	0 - 127	Envelope 3 Sustain
69	64	0 - 127	Envelope 3 Release
70	98	0 - 1	Envelope 3 Repeat Off/On
71	65	0 - 22	Mod 1 Source; See Modulation Source list below
72	66	0 - 254	Mod 1 Amount; -127 to +127
73	67	0 - 47	Mod 1 Destination; See Modulation Destination list below
74	68	0 - 22	Mod 2 Source; See Modulation Source list below
75	69	0 - 254	Mod 2 Amount; -127 to +127
76	70	0 - 47	Mod 2 Destination; See Modulation Destination list below
77	71	0 - 22	Mod 3 Source; See Modulation Source list below
78	72	0 - 254	Mod3 Amount; -127 to +127
79	73	0 - 47	Mod 3 Destination; See Modulation Destination list below
80	74	0 - 22	Mod 4 Source; See Modulation Source list below
81	75	0 - 254	Mod 4 Amount; -127 to +127
82	76	0 - 47	Mod 4 Destination; See Modulation Destination list below
83	81	0 - 254	Mod Wheel Amount; -127 to +127
84	82	0 - 47	Mod Wheel Destination; See Modulation Destination list below
85	83	0 - 254	Pressure Amount; -127 to +127

86	84	0 - 47	Pressure Destination; See Modulation Destination list below
86	85	0 - 254	Breath Amount; -127 to +127
88	86	0 - 47	Breath Destination; See Modulation Destination list below
89	87	0 - 254	Velocity Amount; -127 to +127
90	88	0 - 47	Velocity Destination; See Modulation Destination list below
91	89	0 - 254	Foot Control Amount; -127 to +127
92	90	0 - 47	Foot Control Destination; See Modulation Destination list below
93	96	0 - 4	Unison Mode: 0 1 voice 1 All voices 2 All voices detune1 3 All voices detune2 4 All voices detune3
94	96	0 - 5	Key Assign Mode: 0 Low note priority 1 Low note priority with re-trigger 2 High note priority 3 High note priority with re-trigger 4 Last note hit priority 5 Last note hit priority with re-trigger
95	99	0 - 1	Unison; off/on
96	111	0 - 120	Push It Switch Note Number
97	112	0 - 127	Push It Switch Velocity
98	113	0 - 2	Push It Switch Mode: 0 Normal 1 Toggle 2 Audio In
101	91	30 - 250	BPM tempo
102	92	0 - 12	Clock Divide: 0 Half Note 1 Quarter Note 2 Eighth Note 3 Eighth Note half swing 4 Eighth Note full swing 5 Eighth Note triplets 6 Sixteenth Note 7 Sixteenth Note half swing 8 Sixteenth Note full swing 9 Sixteenth Note triplets 10 Thirty-second Notes 11 Thirty-second Notes triplets 12 Sixty-Fourth note triplets

103	97	0 - 14	Arpeggiator Mode: 0 Up 1 Down 2 Up/Down 3 Assign 4 Random 5 Up 2 Octaves 6 Down 2 Octaves 7 Up/Down 2 Octaves 8 Assign 2 Octaves 9 Random 2 Octaves 10 Up 3 Octaves 11 Down 3 Octaves 12 Up/Down 3 Octaves 13 Assign 3 Octaves 14 Random 3 Octaves
104	100	0 - 1	Arpeggiator; Off/On
105	94	0 - 5	Sequencer Trigger: 0 Normal 1 Normal, no reset 2 No gate 3 No gate/no reset 4 Key Step 5 Audio In
106	101	0 - 1	Gated Sequencer; Off/On
107	77	0 - 48	Sequence 1 Destination; See Modulation Destination list below
108	78	0 - 48	Sequence 2 Destination; See Modulation Destination list below
109	79	0 - 48	Sequence 3 Destination; See Modulation Destination list below
110	80	0 - 48	Sequence 4 Destination; See Modulation Destination list below
120 - 135	120 - 135	0 - 127	Sequence Track1, steps 1-16 0 to 125: Normal sequence step value 126 Reset 127 Rest
136 - 151	136 - 151	0 - 126	Sequence Track 2, steps 1-16 0 to 125: Normal sequence step value 126 Reset
152 - 167	152 - 167	0 - 126	Sequence Track 3, steps 1-16 0 to 125: Normal sequence step value 126 Reset
168 - 183	168 - 183	0 - 126	Sequence Track 4, steps 1-16 0 to 125: Normal sequence step value 126 Reset
184 - 199	184 - 199	32 - 127	Name characters 1-16, in ASCII format

The following tables list the values used with the program parameters to specify modulation destinations and sources.

Mod Destinations	Value
Off	0
Osc 1 Freq	1
Osc 2 Freq	2
Osc 1 and 2 Freq	3
Osc Mix	4
Noise Level	5
Osc 1 Pulse Width	6
Osc 2 Pulse Width	7
Osc 1 and 2 Pulse Width	8
Filter Frequency	9
Resonance	10
Filter Audio Mod Amt	11
VCA Level	12
Pan Spread	13
LFO 1 Freq	14
LFO 2 Freq	15
LFO 3 Freq	16
LFO 4 Freq	17
All LFO Freq	18
LFO 1 Amt	19
LFO 2 Amt	20
LFO 3 Amt	21
LFO 3 Amt	22
All LFO Amt	23
Filter Env Amt	24
Amp Env Amt	25
Env 3 Amt	26
All Env Amounts	27
Env 1 Attack	28
Env 2 Attack	29
Env 3 Attack	30
All Env Attacks	31
Env 1 Decay	32
Env 2 Decay	33
Env 3 Decay	34
All Env Decays	35
Env 1 Release	36
Env 2 Release	37
Env 3 Release	38
All Env Releases	39

Mod 1 Amt	40
Mod 2 Amt	41
Mod 3 Amt	42
Mod 4 Amt	43
External Audio In Level	44
Sub Osc 1 Level	45
Sub Osc 2 Level	46
Feedback Gain	47
Slew*	48

*Appears as a destination in sequences 2 and 4 only.

Mod Sources	Value
Off	0
Sequence Track 1	1
Sequence Track 2	2
Sequence Track 3	3
Sequence Track 4	4
LFO 1	5
LFO 2	6
LFO 3	7
LFO 4	8
Filter Envelope	9
Amp Envelope	10
Envelope 3	11
Pitch Bend	12
Mod Wheel	13
Pressure	14
MIDI Breath	15
MIDI Foot	16
MIDI Expression	17
Velocity	18
Note Number	19
Noise	20
Audio In Envelope Follower	21
Audio In Peak Hold	22

Sysex Messages

Universal System Exclusive Message (Device Inquiry)

Status	Description
1111 0000	System Exclusive (SysEx)
0111 1110	Non-realtime message
0vvv vvvv	If MIDI channel is set to 1 - 16, 0vvvvvvv must match (unless MIDI Channel = ALL); always responds if 0vvvvvvv = 0111 1111.
0000 0110	Inquiry Message
0000 0001	Inquiry Request
1111 0111	End of Exclusive (EOX)

Mopho keyboard responds with:

Status	Description
1111 0000	System Exclusive (SysEx)
0111 1110	Non-realtime message
0vvv vvvv	If MIDI Channel = ALL, 0vvvvvvv = 0111 1111. Otherwise 0vvvvvvv = Channel Number 0 - 15.
0000 0110	Inquiry Message
0000 0010	Inquiry Reply
0000 0001	DSI ID
0010 0111	Mopho Keyboard ID (Family LS)
0000 0001	Family MS
0000 0000	Family Member LS
0000 0000	Family Member MS
0jjj nnnn	Main Software version: jjj - Minor rev; nnnn - Major rev
0000 0000	Voice firmware version LS
0000 0000	Voice firmware version MS
1111 0111	End of Exclusive (EOX)

Request Program Dump

Status	Description
1111 0000	System Exclusive (SysEx)
0000 0001	DSI ID
0010 0111	Mopho Keyboard ID
0000 0101	Request Program Transmit
0000 00vv	Bank Number, 0 - 2
0vvv vvvv	Program Number, 0 - 127
1111 0111	End of Exclusive (EOX)

Mopho will respond by sending out the Program Data in the format described below in *Program Data Dump*.

Request Program Edit Buffer Dump

Status	Description
1111 0000	System Exclusive (SysEx)
0000 0001	DSI ID
0010 0111	Mopho keyboard ID
0000 0110	Request Program Edit Buffer Transmit
1111 0111	End of Exclusive (EOX)

Mopho will respond by sending out the current Program edit buffer in the format described below in *Program Edit Buffer Data Dump*.

Request Global Parameter Dump

Status	Description
1111 0000	System Exclusive (SysEx)
0000 0001	DSI ID
0010 0111	Mopho keyboard ID
0000 1110	Request Global Parameter Transmit
1111 0111	End of Exclusive (EOX)

Mopho will respond by sending out the current values of Global Parameters in the format described below in *Global Parameters Data Dump*.

Program Data Dump

Status	Description
1111 0000	System Exclusive (SysEx)
0000 0001	DSI ID
0010 0111	Mopho keyboard ID
0000 0010	Program Data
0000 00vv	Bank Number, 0 - 2
0vvv vvvv	Program Number, 0 - 127
0vvv vvvv	256 bytes expanded to 293 MIDI bytes in "packed MS bit" format (see page 59.)
1111 0111	End of Exclusive (EOX)

Program Edit Buffer Data Dump

Status	Description
1111 0000	System Exclusive (SysEx)
0000 0001	DSI ID
0010 0111	Mopho keyboard ID
0000 0011	Edit Buffer Data
0vvv vvvv	256 bytes expanded to 293 MIDI bytes in “packed MS bit” format (see page 59.)
1111 0111	End of Exclusive (EOX)

Global Parameters Data Dump

Status	Description
1111 0000	System Exclusive (SysEx)
0000 0001	DSI ID
0010 0111	Mopho keyboard ID
0000 1111	Main Parameter Data
0vvv vvvv	42 nibbles (LS then MS) for 21 Global parameters. Global Parameters are listed starting on page 48.
1111 0111	End of Exclusive (EOX)

Note: The Global Parameters Data Dump is not recognized when received; it is only transmitted when requested. NRPN messages are used to change Globals.

Packed Data Format

Data is packed in 8 byte “packets”, with the MS bit stripped from 7 parameter bytes, and packed into an eighth byte, which is sent at the start of the 8 byte packet.

Example:

Input Data

```
1 A7 A6 A5 A4 A3 A2 A1 A0
2 B7 B6 B5 B4 B3 B2 B1 B0
3 C7 C6 C5 C4 C3 C2 C1 C0
4 D7 D6 D5 D4 D3 D2 D1 D0
5 E7 E6 E5 E4 E3 E2 E1 E0
6 F7 F6 F5 F4 F3 F2 F1 F0
7 G7 G6 G5 G4 G3 G2 G1 G0
```

Packed MIDI data

```
1 00 G7 F7 E7 D7 C7 B7 A7
2 00 A6 A5 A4 A3 A2 A1 A0
3 00 B6 B5 B4 B3 B2 B1 B0
4 00 C6 C5 C4 C3 C2 C1 C0
5 00 D6 D5 D4 D3 D2 D1 D0
6 00 E6 E5 E4 E3 E2 E1 E0
7 00 F6 F5 F4 F3 F2 F1 F0
8 00 G6 G5 G4 G3 G2 G1 G0
```

This explains why it takes 293 MIDI bytes to transmit 256 Program data bytes.

**Dave Smith Instruments
1210 Cabrillo Hwy N
Half Moon Bay, CA 94019-1449
USA**

www.DaveSmithInstruments.com